



# Doors & windows

Thermally insulated profile systems  
made from steel and stainless steel

**JANSEN**

# Minimal heat loss

## Maximum stability

Doors and windows symbolise openness and provide a way in for people, light and air. But they also protect from external influences. The individual requirements for thermal insulation and sound reduction or burglar and bullet resistance determine how doors and windows are to be constructed.

The thermally insulated door and window systems of the Janisol series in steel or stainless steel impress with excellent U values (thermal transmittance) and feature narrow face widths.

The Janisol series is suitable for dry and wet glazing, while the door systems are also available with easy-access thresholds. Whether in public buildings, residential construction or renovation projects, the wide Janisol range with its differentiated, combinable profile series will meet the most demanding of requirements for thermal insulation. The Janisol systems are also at the forefront in terms of security, mechanical strength and durability.

The range includes the following profile series:

- Janisol doors (steel and stainless steel): with a basic depth of just 60 mm, suitable for complex single and double-leaf doors.
- Janisol windows (steel and stainless steel): for generous window surfaces with slimline frame profiles. Side-hung, turn/tilt, bottom-hung, horizontal pivot and double-vent windows are all possible.
- Janisol Primo (steel): highly thermally insulated window system with a basic depth of 60 mm.
- Janisol HI (steel): high insulation – the first Minergie-certified steel window and door system in Switzerland with a basic depth of 80 mm.
- Janisol Arte (steel, stainless steel and Corten): slender thermally insulated windows with face widths of 25 and 40 mm; ideal for the faithful renovation of industrial and loft glazing as well as the windows of listed buildings.
- Janisol lift-and-slide doors for large-scale glazing in residential and commercial projects.

The Janisol systems have successfully passed the tests laid down in the product standard EN 14351-1.

**On this basis, manufacturers can label windows and external doors with the CE mark which is obligatory throughout the EU.**





Palmkernölspeicher am Phönix, Berlin/DE  
Janisol / Janisol-Primo



# Janisol steel systems

## Doors and windows



### Janisol doors – Proven technology in perfect harmony

The flush-fitted profile series is ideally suited for creating visually attractive and structurally sophisticated single and double-leaf doors. The use of high-quality insulating bars and mechanically undercut rolling means that a high degree of rigidity is achieved despite a minimal basic depth of 60 mm. Structural reinforcements can also be easily added. The glass fibre reinforced insulating bars are heat-resistant. As a result, no special precautions are

required before welding the frames. The range of colours available is virtually unlimited; powder coating and wet coating are both possible. The appearance is coordinated to match the other Jansen door systems for fire and smoke protection. The sight lines are practically identical. For the developer, this guarantees that sight lines are identical even where requirements are different.



### Janisol anti-finger-trap doors – Safety and design perfectly combined

The rounded half profiles minimise the risk of injury at the secondary closing edge. This then prevents crushing and shearing points as per DIN 18650. With maintenance-free, high-performance hinge bushes, Janisol anti-finger-trap doors are particularly suitable for buildings with high frequency use by the public, e.g. shopping centres, schools

or hospitals. The Janisol anti-finger-trap door meets the product standard EN 14351-1 for external doors and is CE certified. The anti-finger-trap doors are compatible with the Janisol and Jansen-Economy 60 range of profiles. Integrated door closers and automatic side-hung door drives can also be installed.

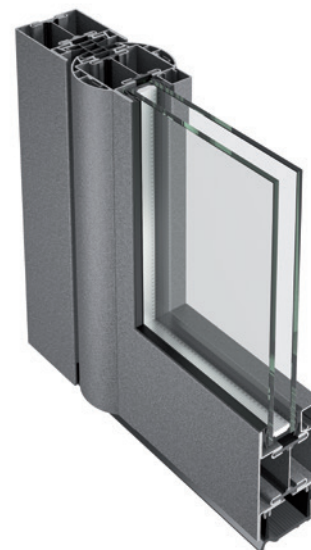



## Janisol windows – Modern technology with a classical appearance

Torsionally rigid, welded frames allow large windows with extremely slender profiles. Arched windows, structural reinforcement and aesthetic adaptations of standard steel profiles can also be produced cost-effectively in individual units and small quantities. As a result, the Janisol system is very much in demand, not only for newbuilds, but also for renovation projects.

Our range of products is completed by a system-compatible and easy-to-install range of fittings (surface-mounted or concealed). Side-hung, turn/tilt, bottom-hung, horizontal pivot and double-vent windows, fixed glazing or combinations of these are all possible.

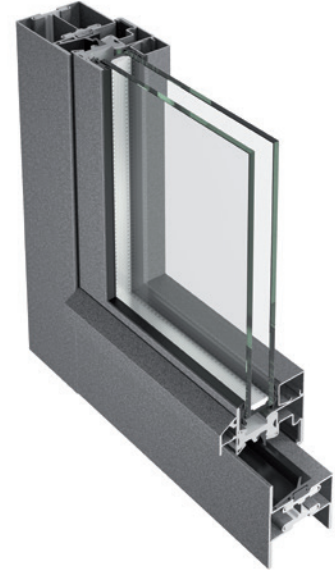

## Janisol Primo – High-quality insulation in the smallest of spaces

This thermally insulated profile system with a construction height of only 60 mm (64 mm vent) enables efficient fabrication of fixed glazing and windows (side-hung, turn/tilt, double-vent and bottom-hung).

All window vents have a centre gasket and a rebate gasket on the room side. We stock a range of system-tested fittings with single-handed operation and multi-point locking for all possible opening types.

Identical profile cross-sections greatly simplify the fabrication of Janisol Primo, and also allow them to be combined with tried-and-tested Janisol profiles.

As a holistic approach to buildings is adopted, energy saving measures and thermal insulation are playing an ever-greater role. For both economic and ecological reasons, the window should be accorded greater importance.

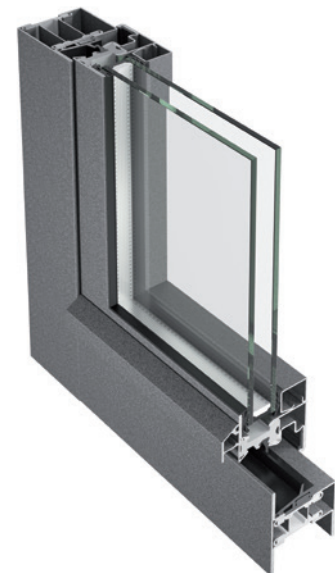



Example of Janisol doors

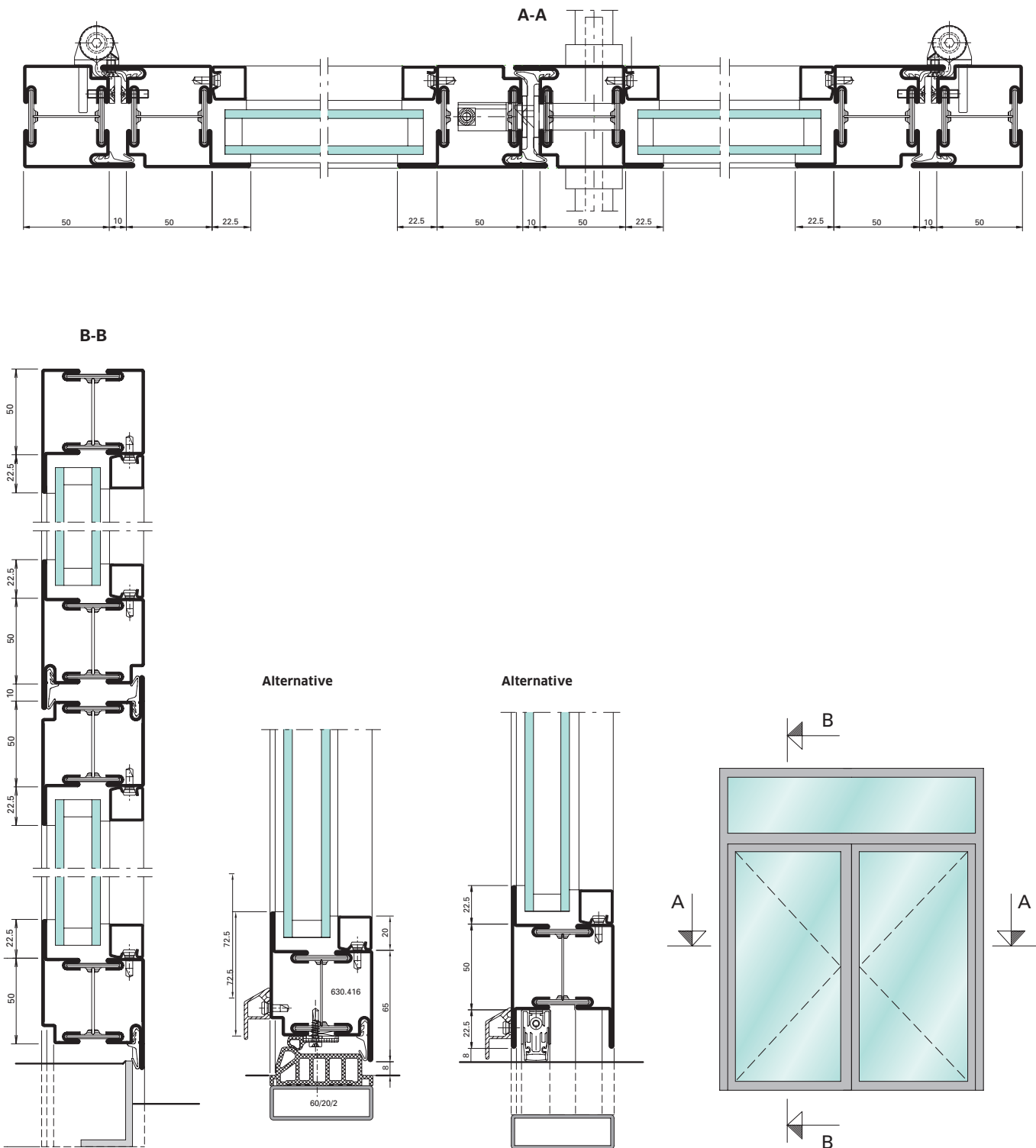



Example of Janisol windows

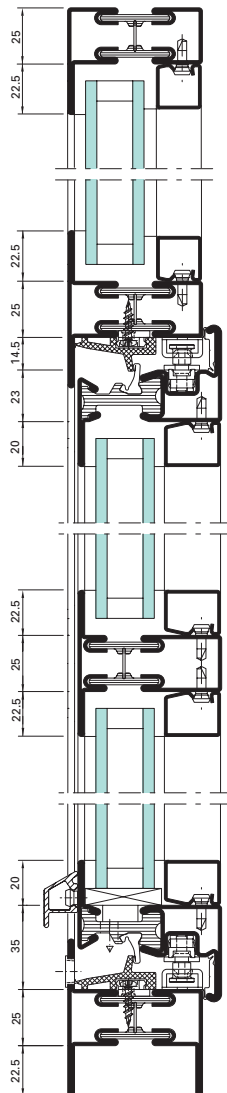
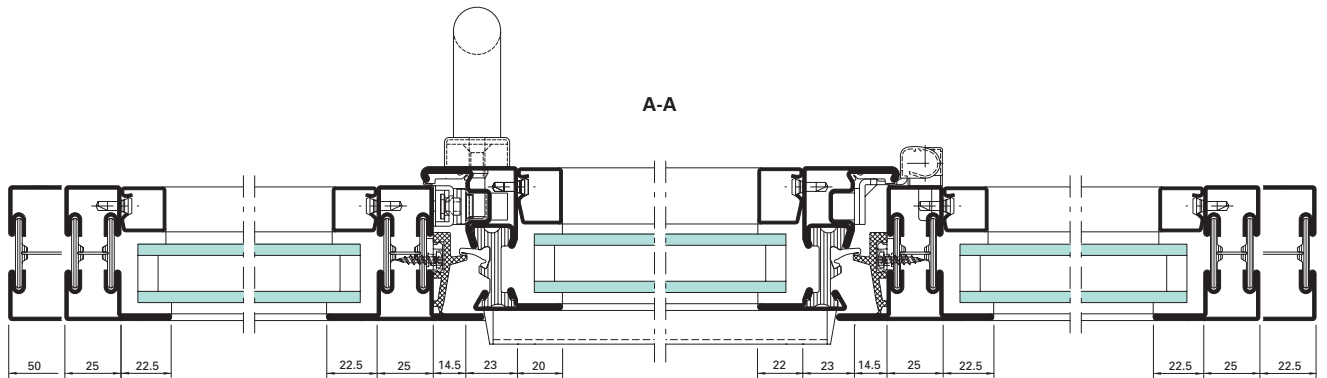

Concealed window fitting

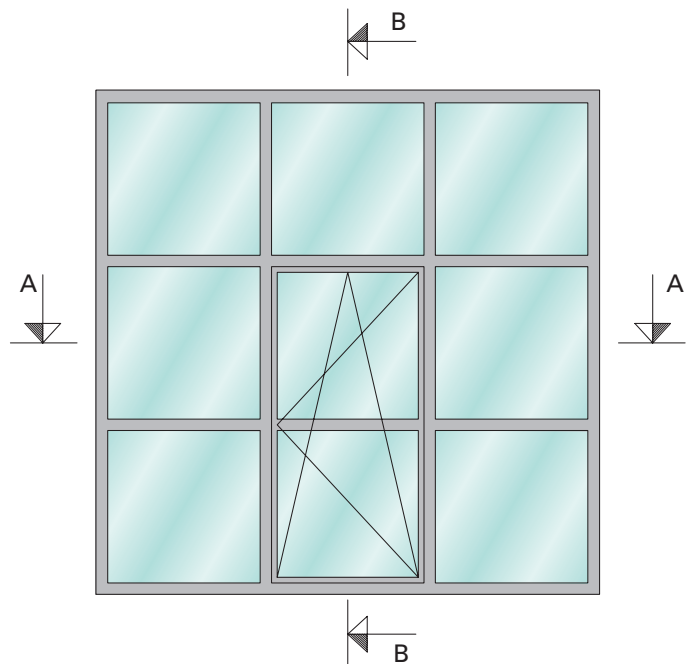
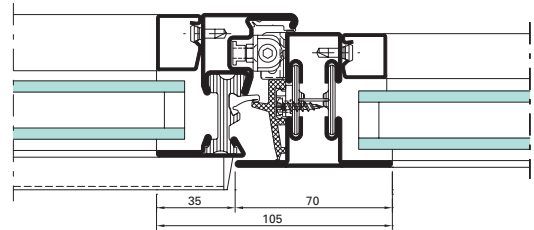



Example of Janisol Primo windows

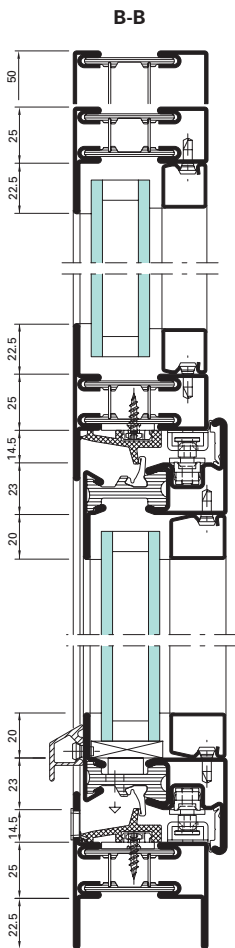
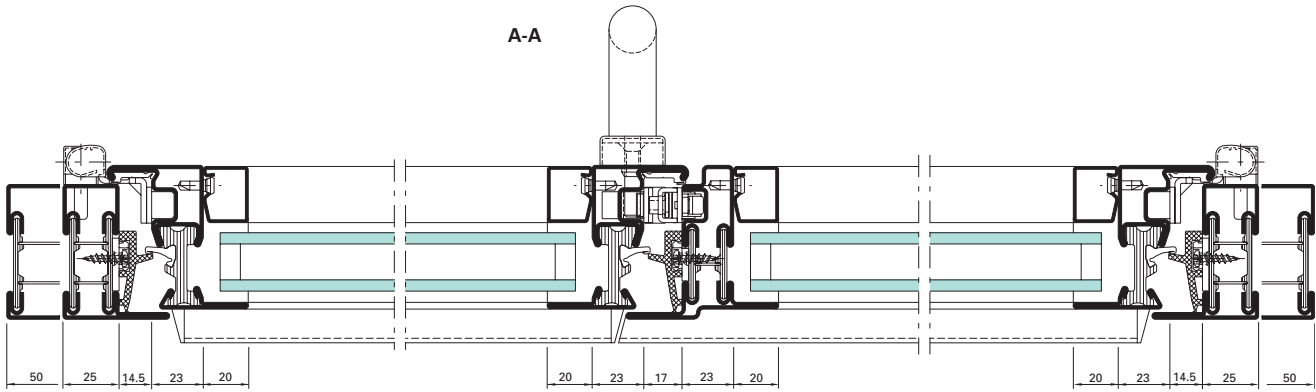

Concealed window fitting

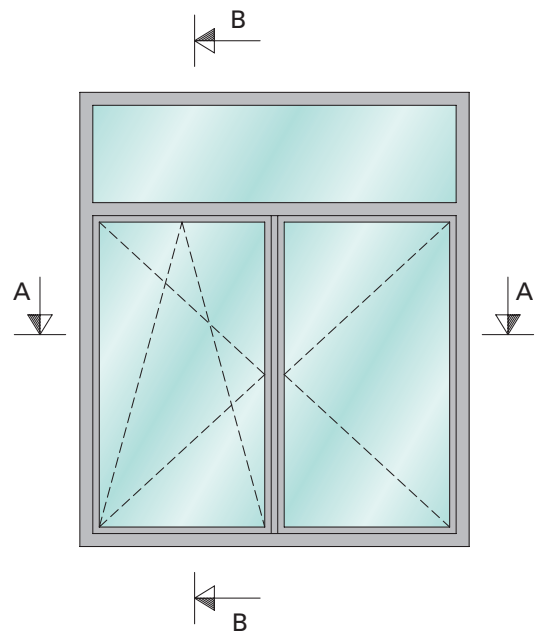
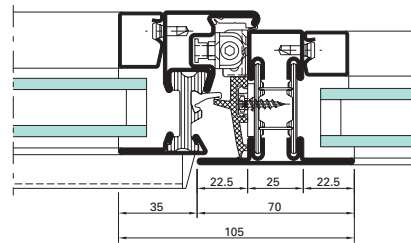









Perchtoldsdorf castle, Perchtoldsdorf/AT  
(Janisol stainless steel doors)



# Janisol stainless steel Doors and windows



## Janisol stainless steel doors

The thermally insulated stainless steel profiles are based on tried and tested Janisol technology. Profiles and sizes are the same as those in the Janisol range. This makes it possible for the designer to combine both types of steel easily and for the fabricator to use identical accessories and fabrication tools. The range is complemented by a comprehensive range of stainless steel fittings. The profile surface is available from stock in a mill finish or polished.

## Janisol stainless steel windows

Whether you are considering using stainless steel for functional or aesthetic reasons, Janisol windows meet both requirements. A comprehensive range of fittings enables the construction of side-hung, turn/tilt, double-vent and bottom-hung windows.

These slimline, thermally insulated stainless steel profiles complement the tried-and-tested Janisol range, adding variant made from stainless steel of grade 1.4401 (AISI 316).





Example of Janisol stainless steel doors

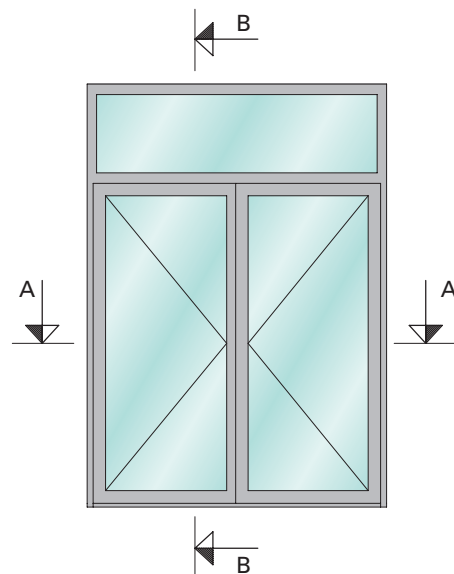
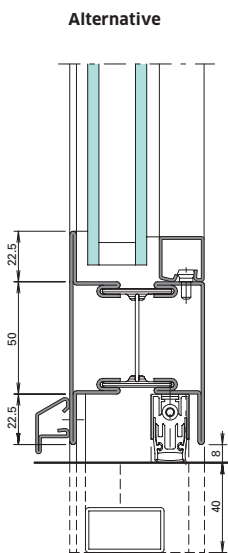
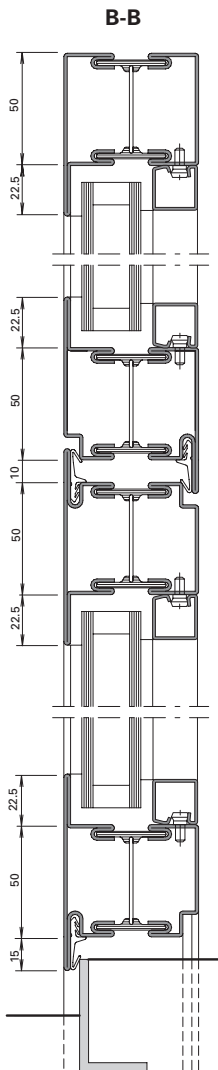
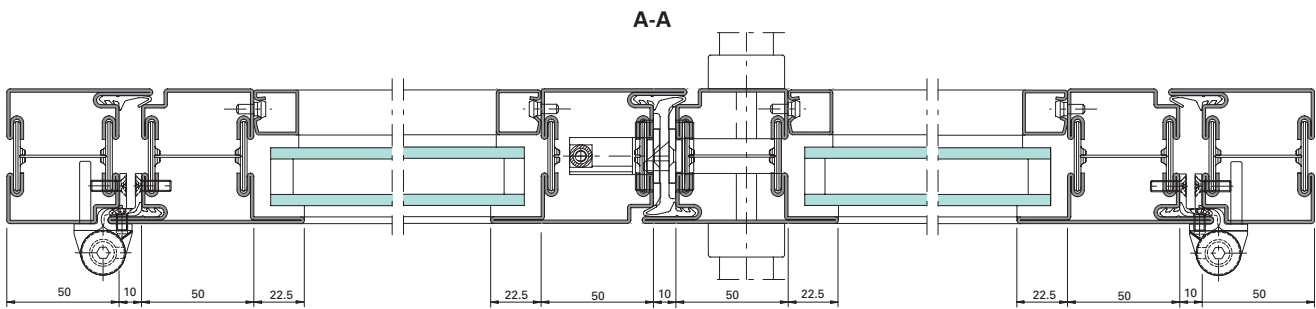

Example of Janisol stainless steel windows

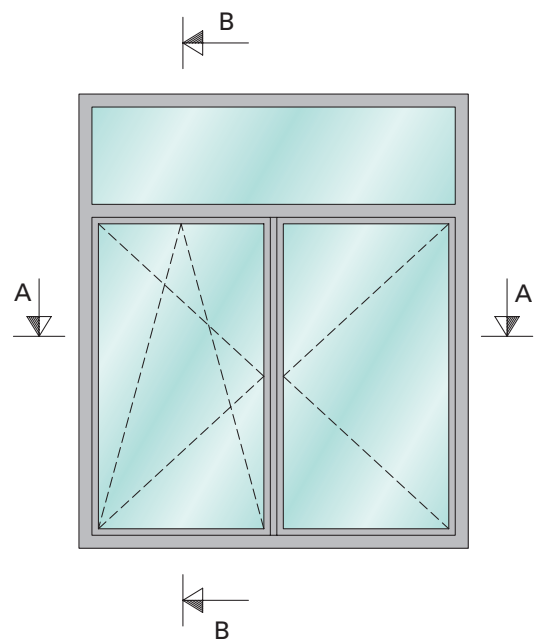
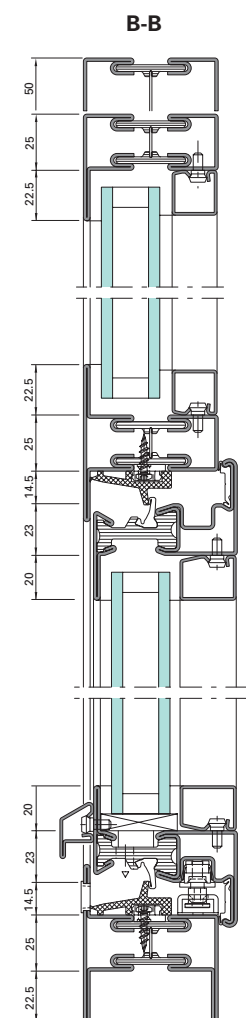
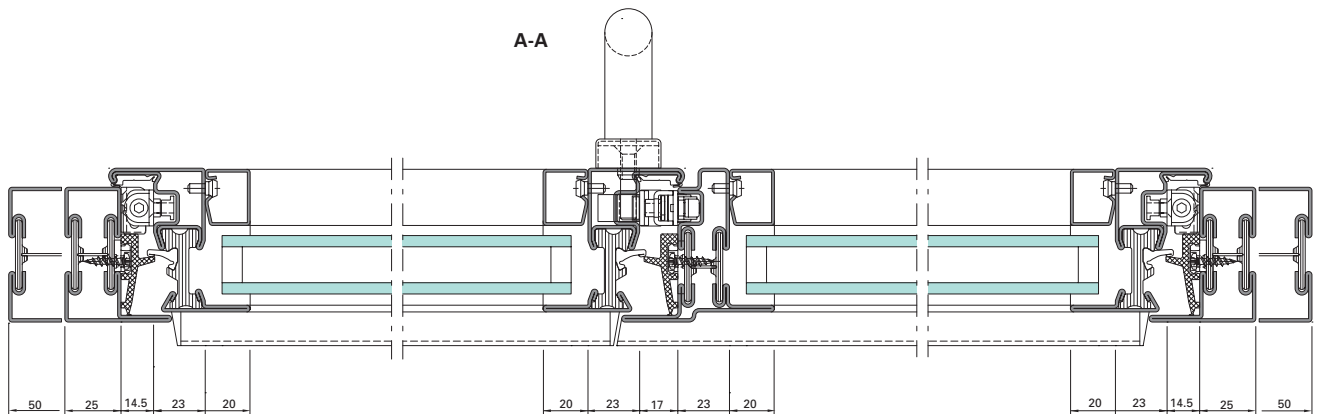



# Janisol folding wall

## Flexible room design



### Steel folding wall – thermally broken

The Janisol folding wall is based on the Janisol thermally insulated system. Flexible in use, the Janisol folding wall system can be used as a room divider as well as for outside areas, and can be inward or outward-opening. A compatible range of fittings and accessories ensures proper, smooth

and quiet operation. A range of designs is available for the threshold. Depending on the size and loading, profiles with a face width of 25 mm or 50 mm can be used. The load-bearing capacity of the top running gear is up to 200 kg, which in turn permits leaf weights of up to 100 kg.



Example of Janisol folding wall

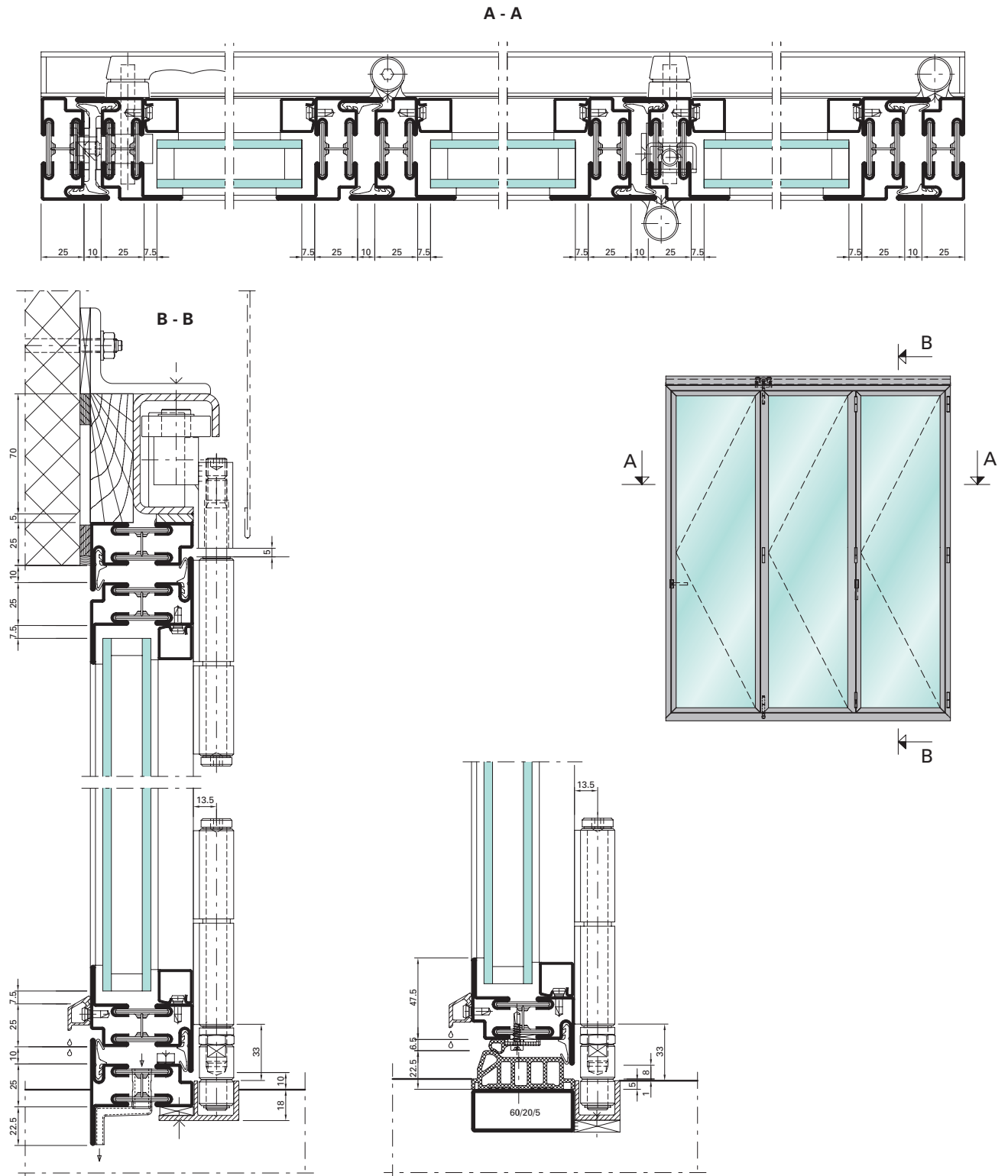

# Profile range Janisol doors and windows

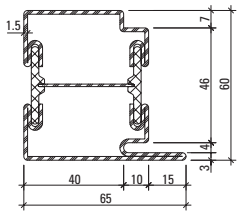

630.013  
630.013 Z  
[630.013.01](#)

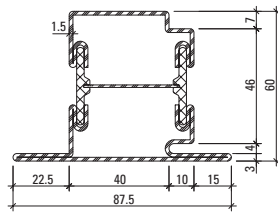

630.114  
630.114 Z  
[630.114.01](#)

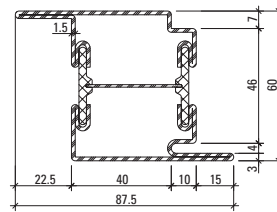

630.416  
630.416 Z  
[630.416.01](#)

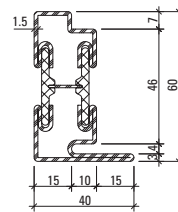

630.010  
630.010 Z

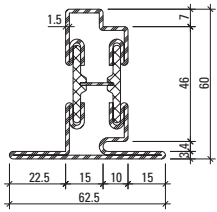

630.110  
630.110 Z

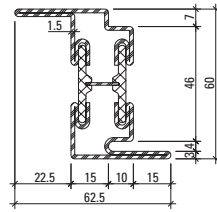

630.411  
630.411 Z

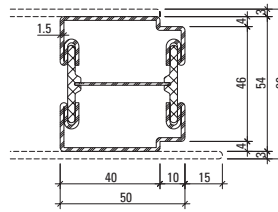

600.010 Z

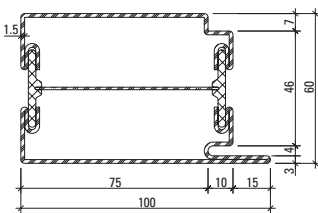

630.016  
630.016 Z  
[630.016.01](#)

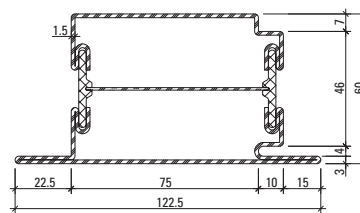

630.115  
630.115 Z  
[630.115.01](#)

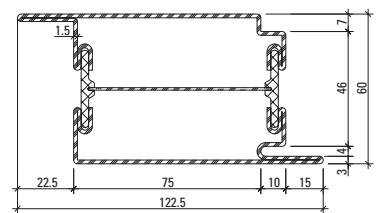

630.417  
630.417 Z  
[630.417.01](#)

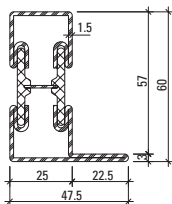

601.635  
601.635 Z  
[601.635.01](#)

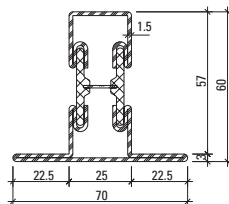

602.635  
602.635 Z  
[602.635.01](#)

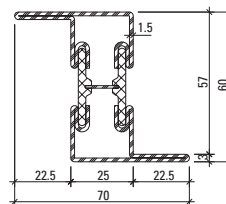

603.635  
603.635 Z

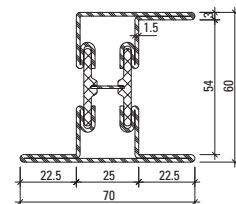

605.635  
605.635 Z



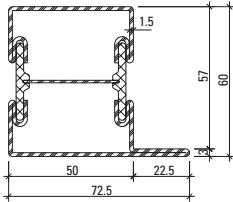

601.685  
601.685 Z  
601.685.01

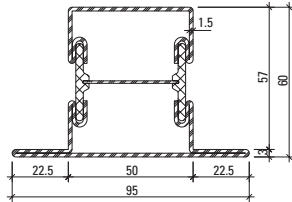

602.685  
602.685 Z  
602.685.01

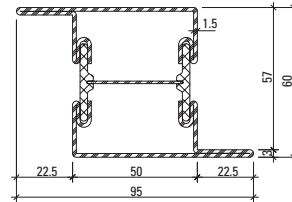

603.685  
603.685 Z

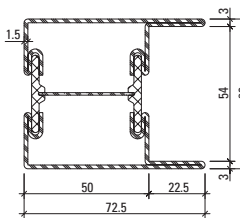

604.685  
604.685 Z

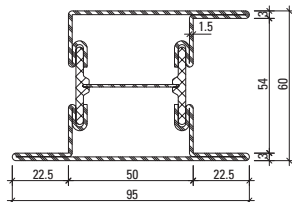

605.685  
605.685 Z  
605.685.01

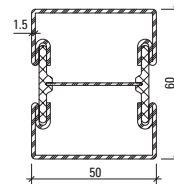

600.005  
600.005 Z

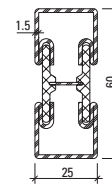

600.006  
600.006 Z

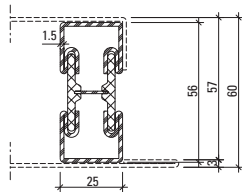

600.002  
600.002 Z

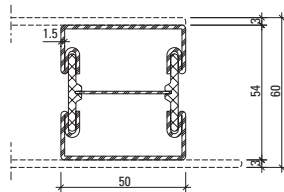

600.007 Z

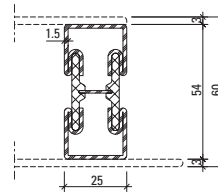

600.008 Z

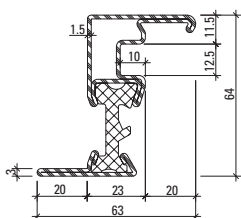

630.900  
630.900 Z  
630.900.01

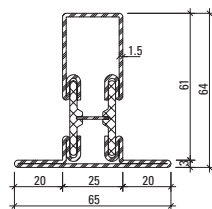

602.636 Z

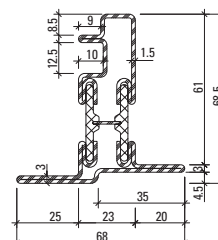

630.901 Z  
630.901.01

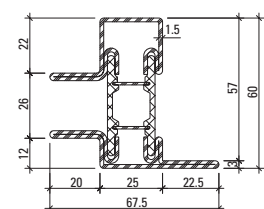

601.699.6 Z

**Part no.**

without addition = bright  
with Z = strip galvanised steel

01 = Stainless steel, bright,  
Material 1.4401 (AISI 316)

# Profile range Janisol Primo windows

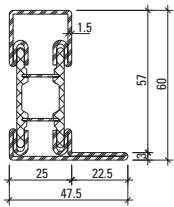

601.635.6 Z

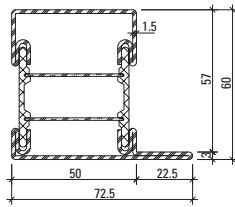

601.685.6 Z

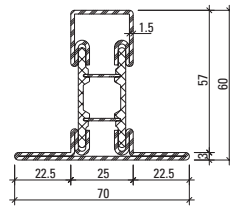

602.635.6 Z

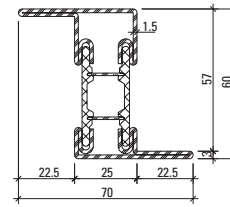

603.635.6 Z

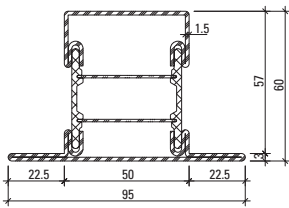

602.685.6 Z

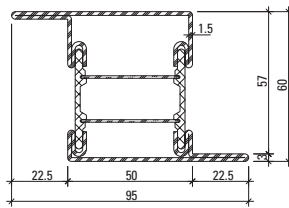

603.685.6 Z

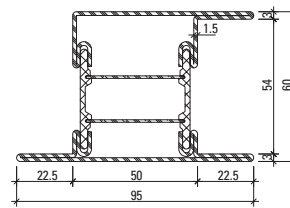

605.685.6 Z

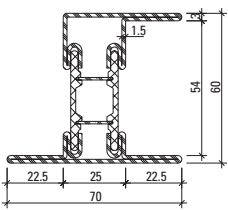

605.635.6 Z

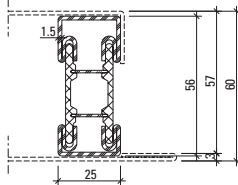

600.002.6 Z

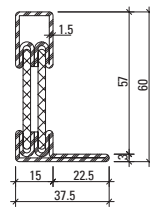

601.634.6 Z

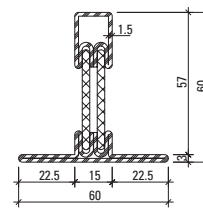

602.634.6 Z

Z = strip galvanised steel







# Janisol HI

## For powerful insulation



### Highly insulated steel doors reduce thermal transmittance to a minimum

In busy public buildings in particular, the requirements for security, durability and thermal insulation have increased dramatically. Janisol HI steel doors conveniently combine mechanical stability with high thermal insulation properties in one single steel profile system.

Thanks to insulating bars made from glass fibre-reinforced polyurethane, Janisol HI achieves  $U_d$  values to  $1.0 \text{ W/m}^2\text{K}$ .

With a basic depth of 80 mm, infill unit thicknesses of up to 57 mm can be used. A comprehensive and coordinated range of fittings and accessories, as well as a range of thresholds, which can be selected to suit the situation, provide the perfect solution for all possible applications. Thanks to the specially formed insulating bars, the lock can be installed in the centre of the profile very easily and efficiently.



MINERGIE®

### Steel windows with optimum thermal break

Modern windows must meet a number of different demands and perform a variety of functions. They must save energy, be airtight, watertight and easy to use, meet structural requirements, but also be highly attractive. Janisol HI steel windows and fixed glazing feature insulating bars made from glass fibre-reinforced polyurethane and boast optimum thermal and structural properties. They achieve  $U_w$  values to  $0.69 \text{ W/m}^2\text{K}$  for fixed

glazing and  $0.8 \text{ W/m}^2\text{K}$  for windows. With a basic depth of 90 mm, vent heights of up to 2800 mm and a vent weight of 180 kg are possible. What is more, different infill unit thicknesses of up to 67 mm can be used. Due to the slimline external face width and the wide variety of coating options, Janisol HI steel windows can meet high thermal insulation requirements in terms of both function and design.

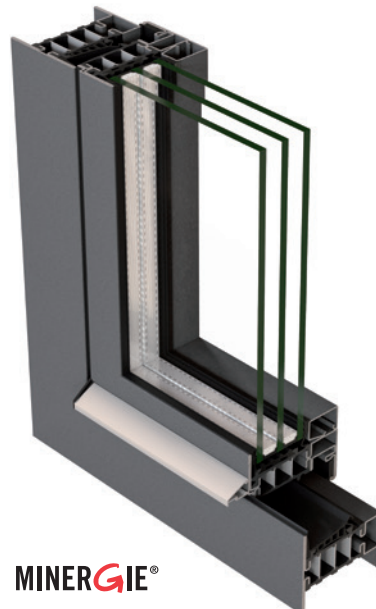

MINERGIE®





Example of Janisol HI doors

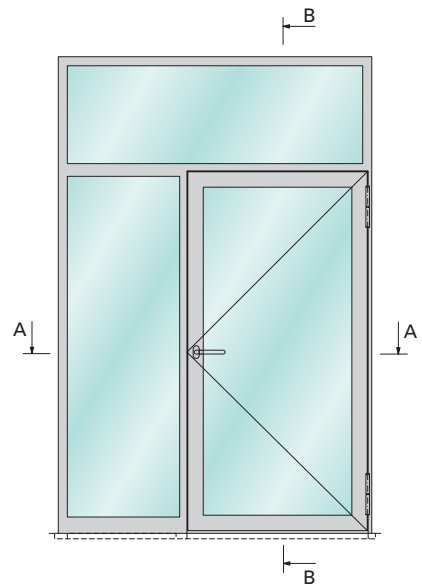
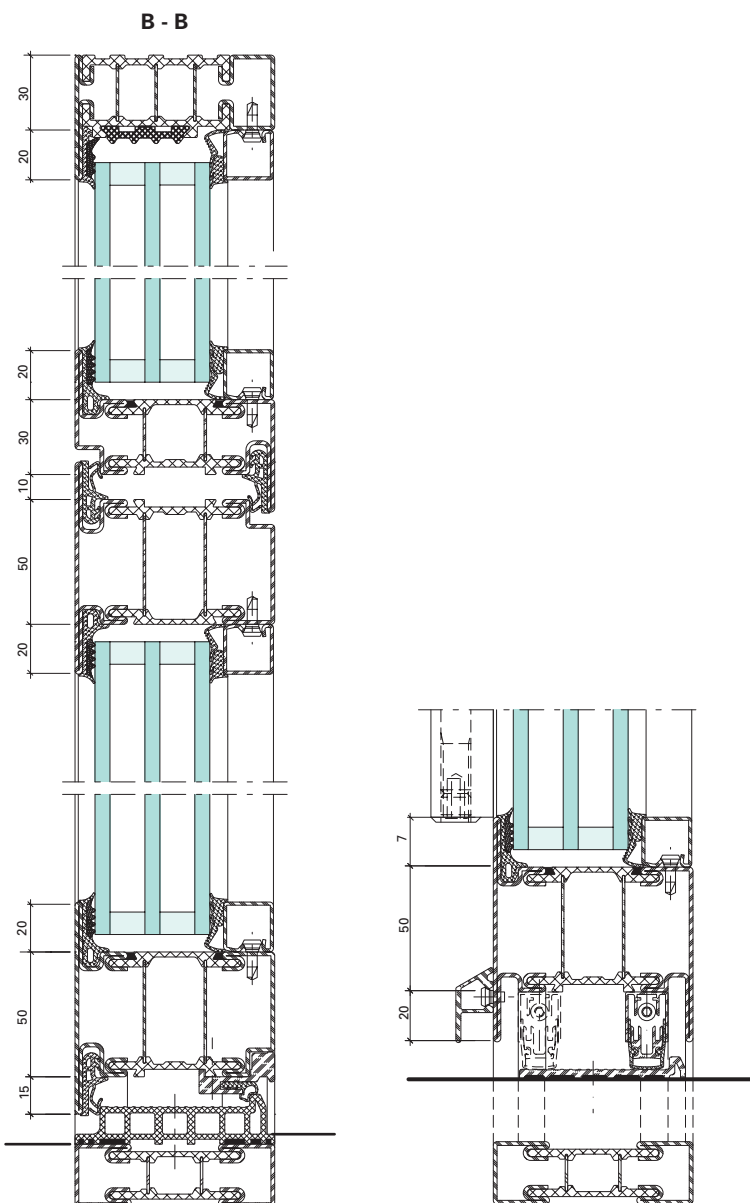
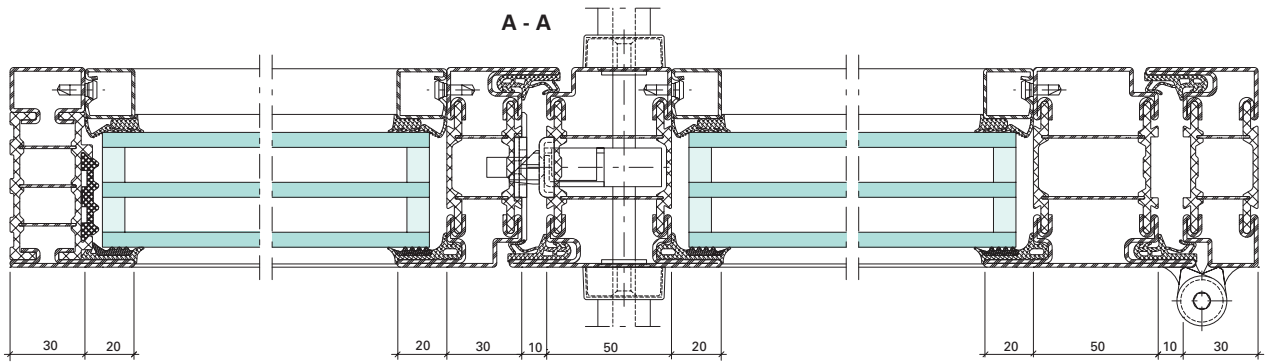

Example of Janisol HI windows

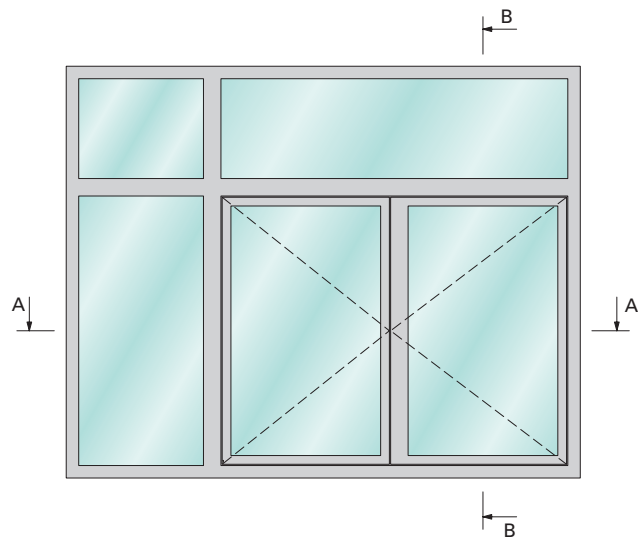
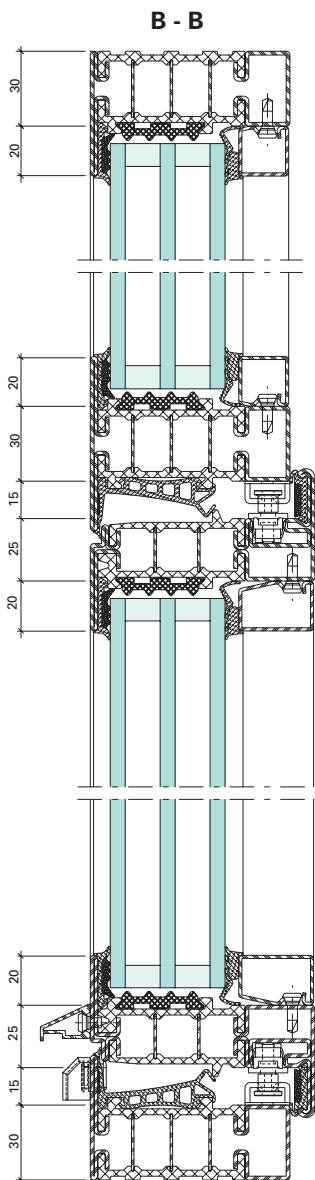
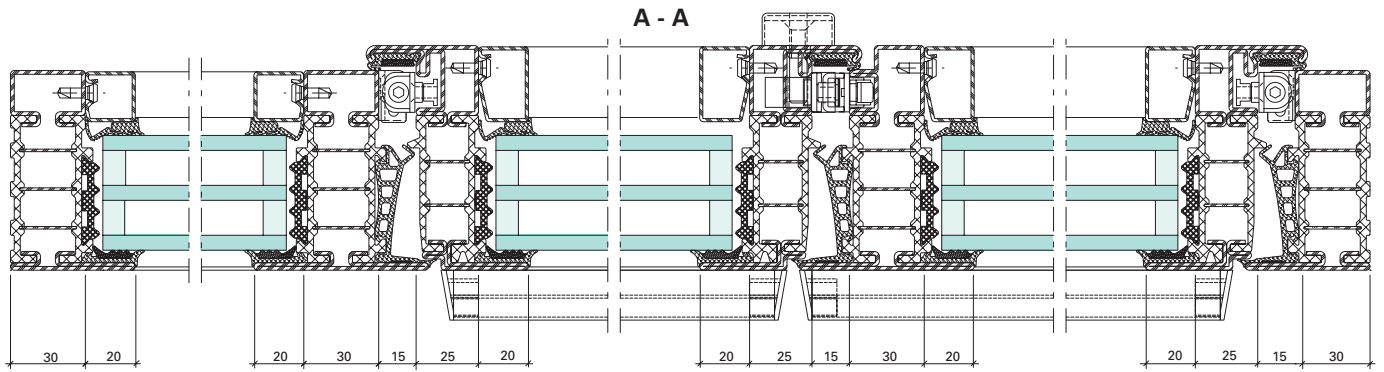



# Profile range Janisol HI

## Doors

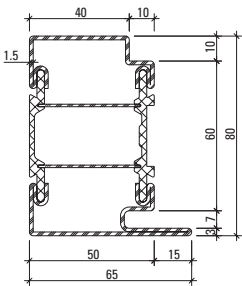

680.013 Z

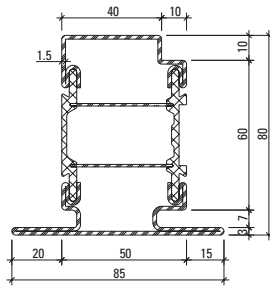

680.114 Z

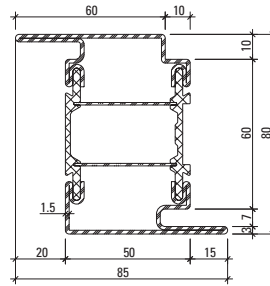

680.416 Z

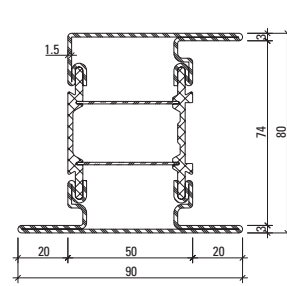

680.652 Z

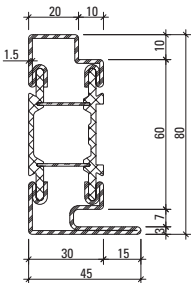

680.010 Z

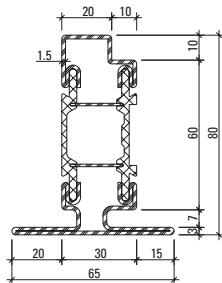

680.110 Z

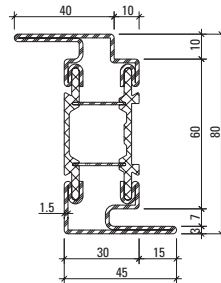

680.411 Z

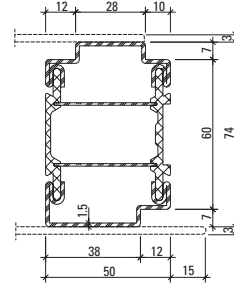

680.051 Z

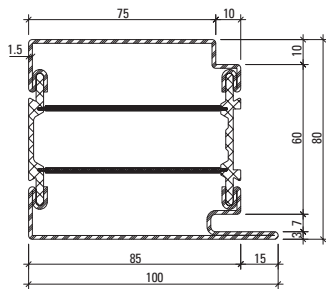

680.016 Z

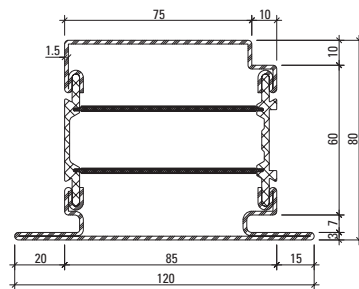

680.115 Z

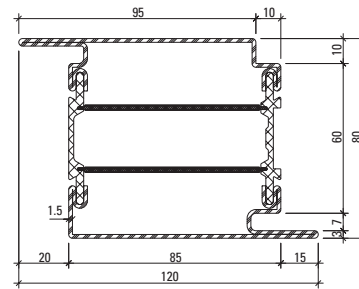

680.417 Z

Z = strip galvanised steel

**Fixed glazings**

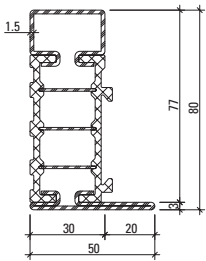

681.630 Z

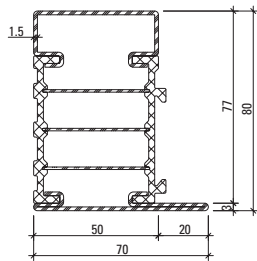

681.650 Z

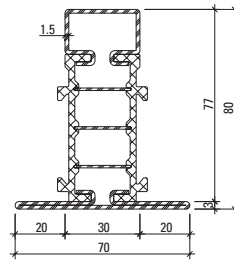

682.630 Z

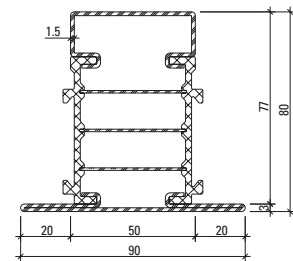

682.650 Z

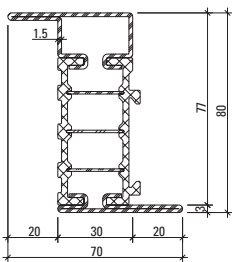

683.630 Z

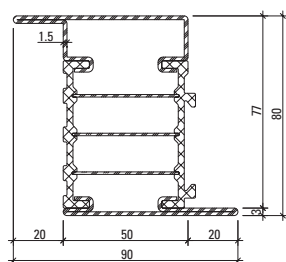

683.650 Z

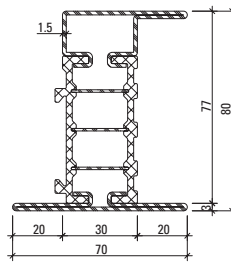

685.630 Z

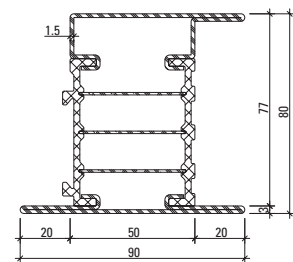

685.650 Z

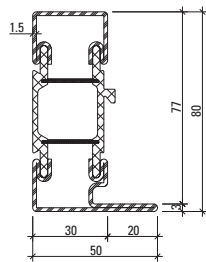

681.635 Z

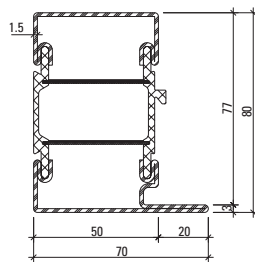

681.655 Z

**Windows**

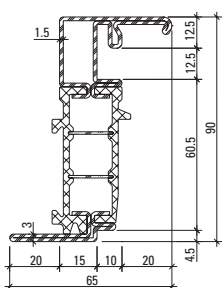

680.900 Z

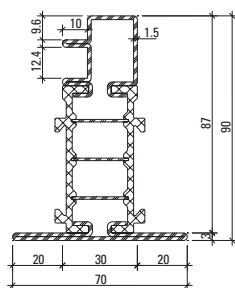

680.901 Z

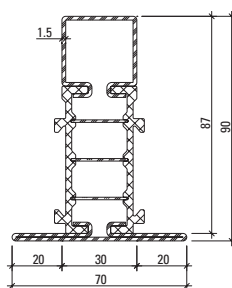

680.902 Z

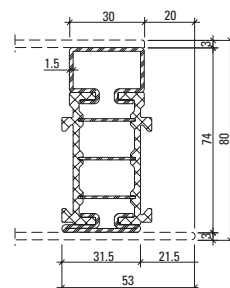

680.060 Z

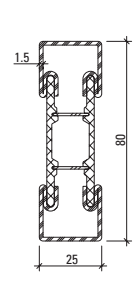

600.012  
600.012 Z



# Janisol Arte 2.0

## The new generation



### Simplified fabrication; new materials for profiles

The second generation of the Janisol Arte window system now offers profiles made from stainless steel and Corten steel as well as a wide range of profiles. The integrated weatherstrip groove simplifies and speeds up fabrication. A large selection of glazing beads is also available in a variety of different materials.

The wide range of opening types is ideally suited for the renovation of old windows but also for modern residential construction. With the narrowest profile face widths of only 25 or 40 mm for fixed glazing and a basic depth of 60 mm, intricate yet stable constructions with a large proportion of glass and excellent thermal insulation can be created.

#### Design benefits

- Inward and outward-opening fixed glazing/window vents
- Single and double-vent windows
- Inward-opening side-hung, bottom-hung and double-vent windows
- Outward-opening side-hung, top-hung, double-vent, horizontal pivot and vertical pivot windows, projected top-hung windows
- Vent sizes of 1000 × 2400 mm
- Vent weight of up to 150 kg
- Unit thicknesses from 20 to 47 mm
- $U_w$  value from 0.8 W/m<sup>2</sup>K
- Multi-point window locking
- New materials for profiles: stainless steel and Corten
- Burglar resistance tested in accordance with EN 1627 up to RC2

#### Fabrication benefits

- Composite technology tested in accordance with EN 14024
- CE classification in accordance with EN 14351-1
- Optimum weldability of the profile frame due to the ZF surface finish
- Mechanical strength tested in accordance with EN 13115
- Impact resistance tested in accordance with EN 13049



Janisol Arte 2.0



Janisol Arte 2.0 stainless steel



Janisol Arte 2.0 Corten

## Janisol Arte vertical pivot window

The new Janisol Arte pivot window may be used as a project solution.

- Vent weights of up to 120 kg
- Tested unit: 1570 × 1570 mm
- Vent weight of up to 20 bis 47 mm, glazing installed by means of wet glazing



## Janisol Arte horizontal pivot window

The new Janisol Arte horizontal pivot window has been successfully CE marked. Vents of up to 1400 × 1600 mm can be constructed as manual or motorised versions.

- Vent weights of up to 100 kg
- Watertightness 8A - 450 Pa
- Air permeability up to class 4
- Sound reduction up to 40 dB



## Janisol Arte sliding doors

With the extremely slimline steel profile system Janisol Arte, large sliding doors can be created with narrow face widths and a high degree of stability. Originally developed by Jansen for the reconstruction of historic windows, Janisol Arte now offers architects and developers the opportunity to create large glass fronts.

- Unit sizes of up to 3000 × 2500 mm (W×H)
- Max. weight of 150 kg per leaf
- Insulating glass of 20 to 34 mm
- $U_w$  value of 1.5 W/m<sup>2</sup>K
- Welded steel half profiles in combination with glass fibre-reinforced high-performance plastics (100% recyclable) produce particularly stable frames
- Profile face widths of just 40 mm ensure increased light penetration and also increase the energy efficiency of the building
- CE marking in accordance with EN 14351-1
- Profile rolling technology tested in accordance with EN 14024
- Sound reduction of up to 41 dB



Janisol Arte 2.0 profile range

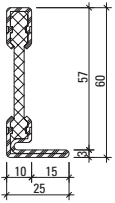

601.611 Z  
601.611.01  
601.611.09

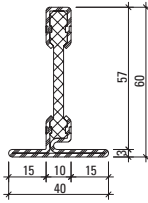

602.611 Z  
602.611.01  
602.611.09

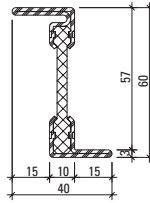

603.611 Z  
603.611.01  
603.611.09

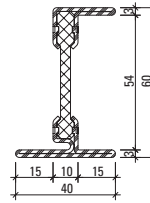

605.611 Z  
605.611.01  
605.611.09

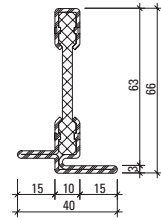

602.612 Z  
602.612.01  
602.612.09

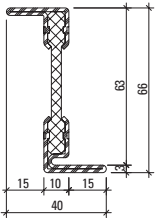

603.612 Z  
603.612.01  
603.612.09

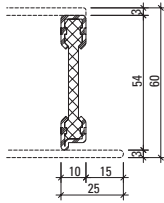

600.609 Z

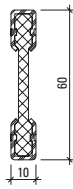

600.610 Z

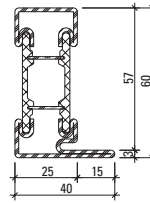

601.615 Z  
601.615.09\*

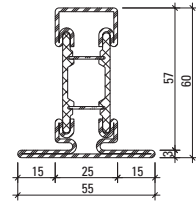

602.615 Z  
602.615.01  
602.615.09\*

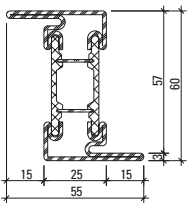

603.615 Z  
603.615.09\*

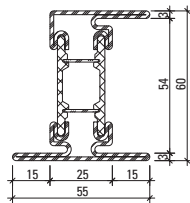

605.615 Z  
615.615.09\*

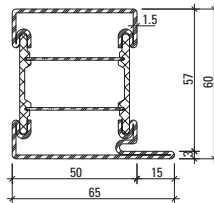

601.616 Z

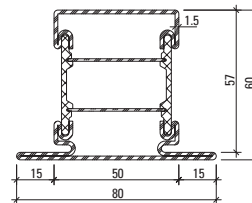

602.616 Z

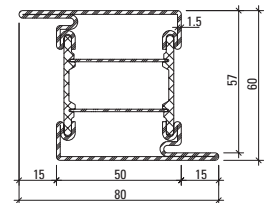

603.616 Z

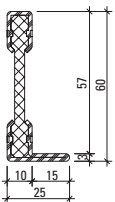

601.610 Z

Part no.

with Z = strip galvanised steel

with 01 = Stainless steel, bright, material 1.4401 (AISI 316)

with 09 = Steel KB DOCOL 355W (Corten)

\* = on request



Example of Janisol Arte 2.0

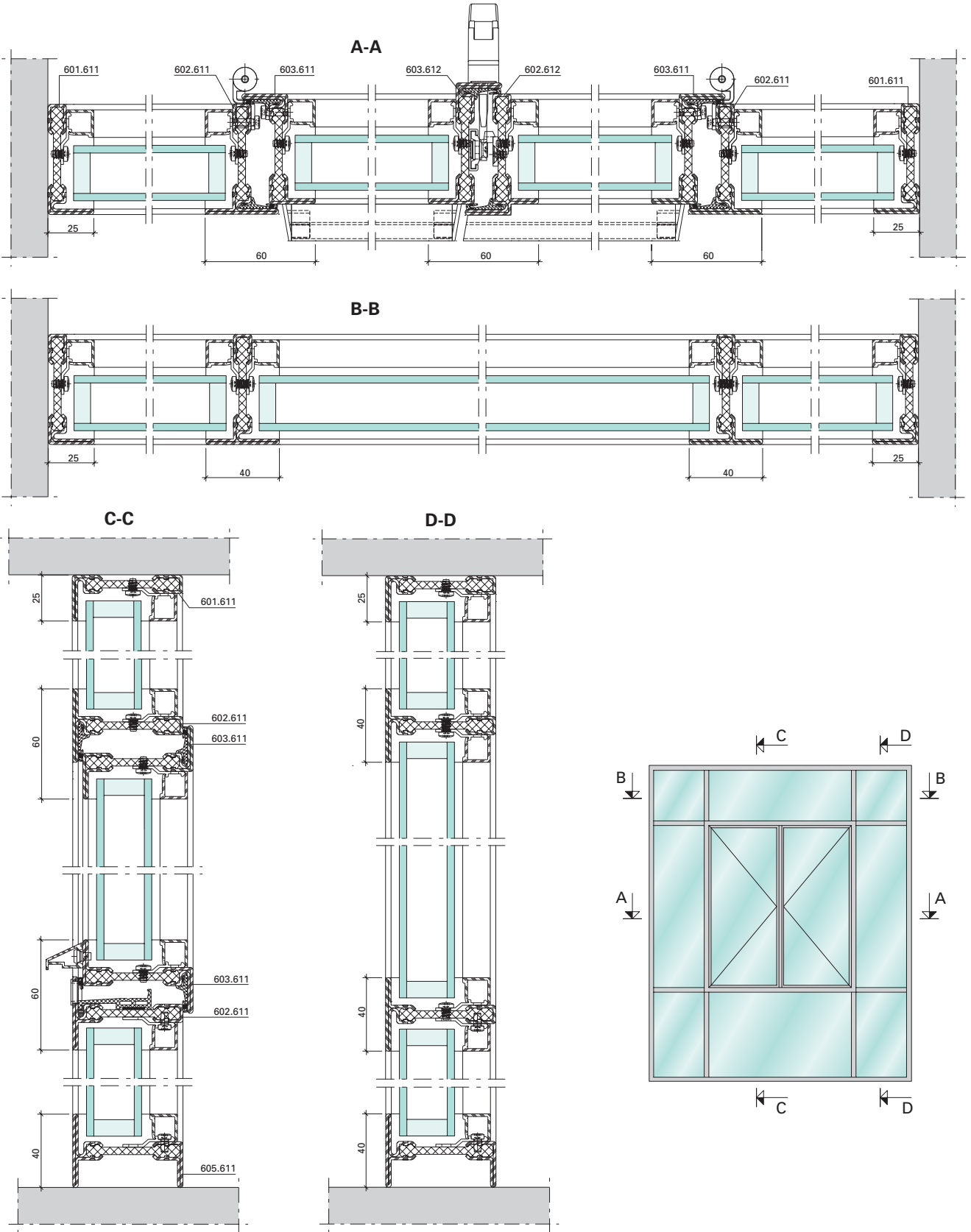

Example of Janisol Arte with side-hung and horizontal pivot windows

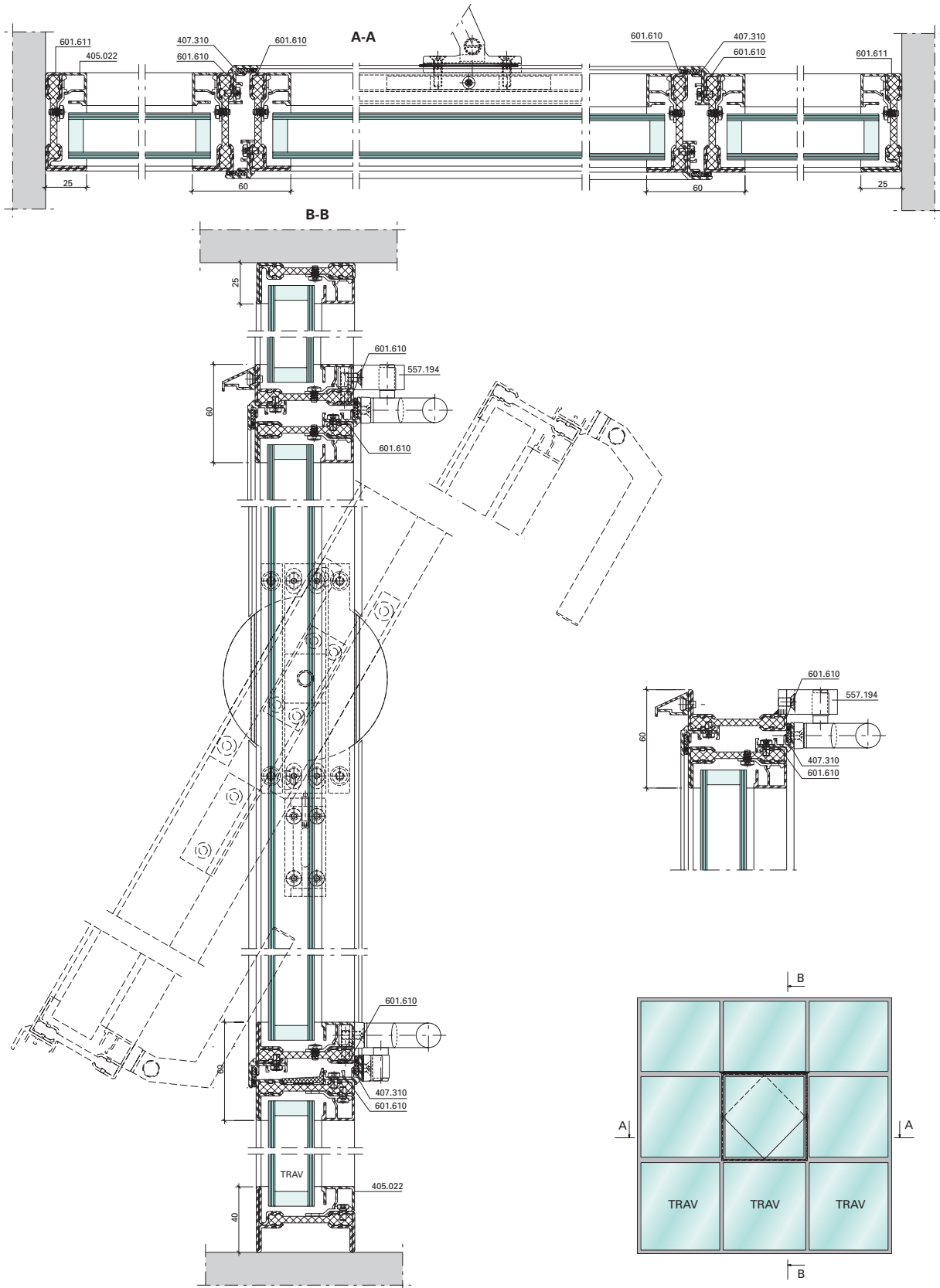

Example of Janisol Arte sliding door

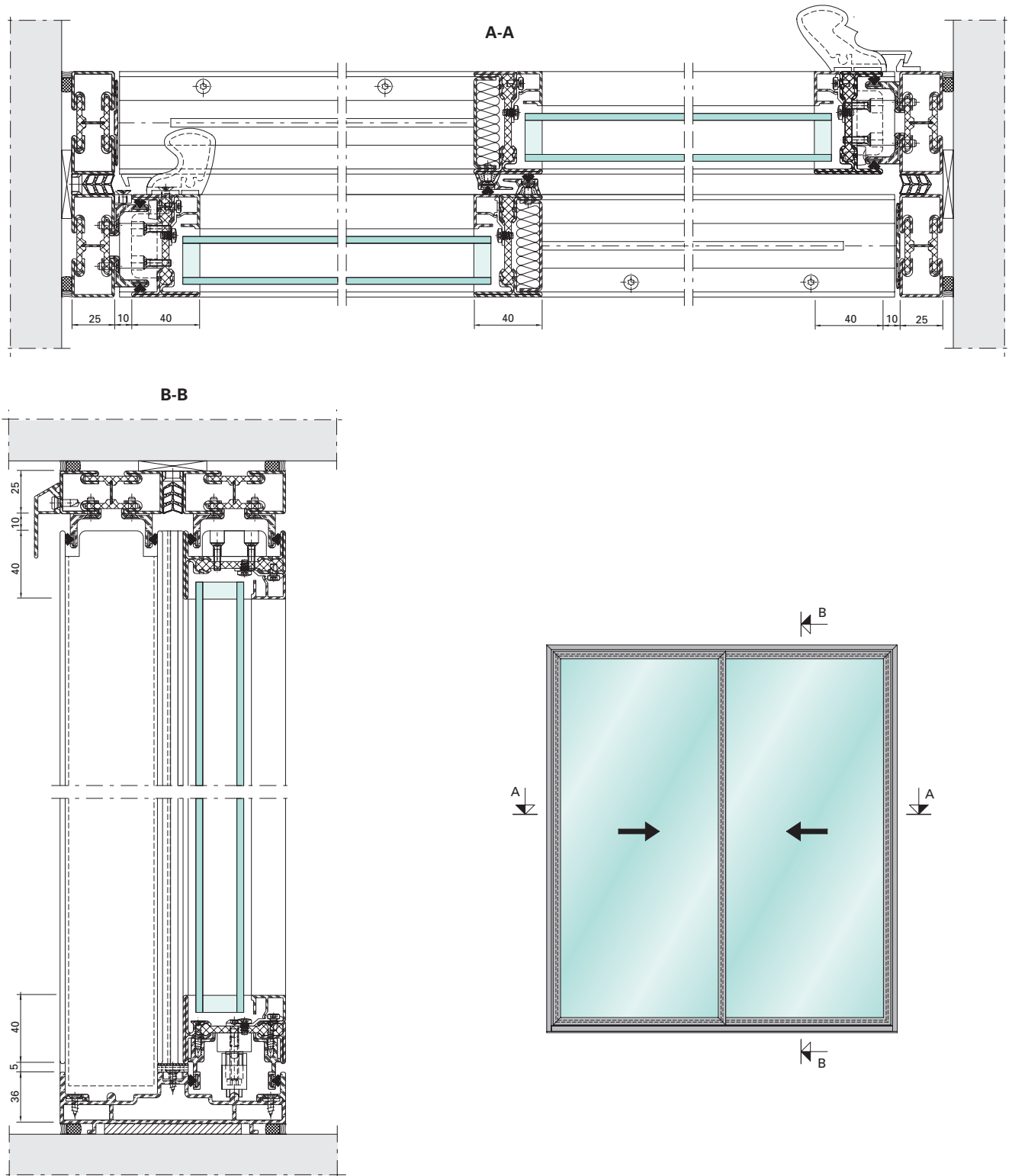



# Janisol Arte 66

## Slim tilt and turn windows



### Tilt and turn windows made from steel profiles

With Janisol Arte 66, Jansen is expanding its range of systems to include an attractive variation. The basic depth of 66 mm enables the use of stronger glass, with a vent height of up to 2300 mm. This makes it possible to have the turn/tilt opening type, even with the special requirements of listed buildings for narrow frames. With the concealed fittings, they meet architects' and developers' demands for a uniform design and clear lines which do not allow any visual interruption. The Euro grooves make it easier for fabricators to install the fittings, while the new glazing bead system facilitates installation of the panes. Fabrication with push-in gasket or dry glazing takes place in the usual way, as with the Janisol and Janisol Arte 2.0 steel profiles – this ensures a high level of process reliability.

#### Design benefits

- Thermally insulated steel system for windows and fixed glazing
- Basic depth 60/66 mm, window vent 70 mm
- Narrow face widths: Window sash bars 40 mm  
Frame including vent from 53 mm  
Double vent assembly 76 mm
- Single and double-vent side-hung and turn/tilt windows and bottom-hung windows, inward-opening
- Side-hung and turn/tilt window vents up to 2300 mm height
- Vent weights up to 180 kg
- Infill unit thicknesses from 15 to 39 mm, glazing installed by means of dry or wet glazing
- Suitable for powder and wet paint coating

#### Fabrication benefits

- Composite technology tested in accordance with EN 14024
- CE classification in accordance with EN 14351-1
- Optimum weldability of the profile frame due to the ZF surface finish
- Mechanical strength tested in accordance with EN 13115
- Impact resistance tested in accordance with EN 13049

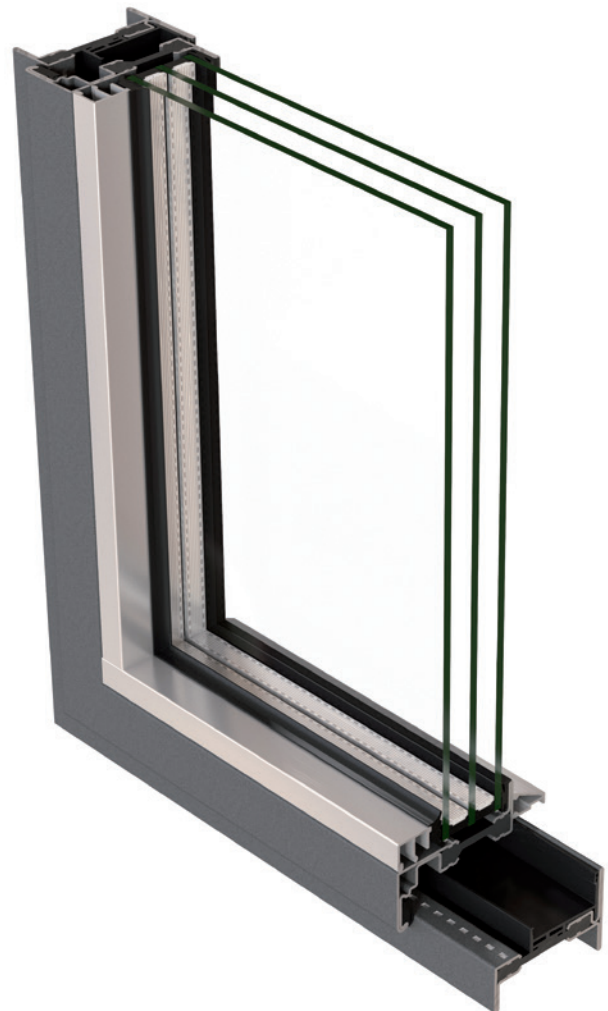

Janisol Arte 66 profile range

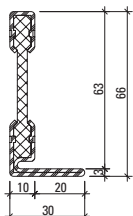

601.630 Z  
601.630.09

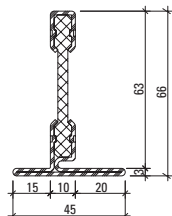

602.630 Z  
602.630.09

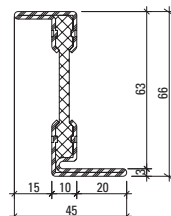

603.630 Z  
603.630.09

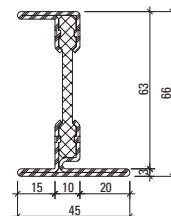

605.630 Z  
605.630.09

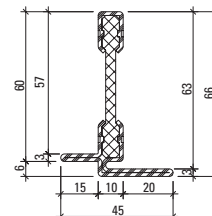

602.631 Z  
602.631.09

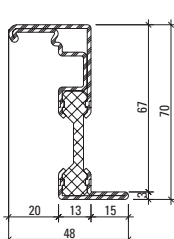

610.900 Z  
610.900.09

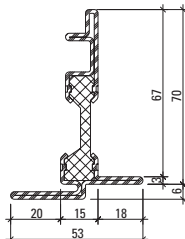

610.901 Z  
610.901.09

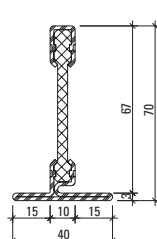

602.611.7 Z  
602.611.79

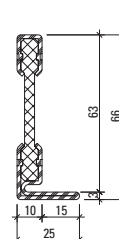

601.612 Z

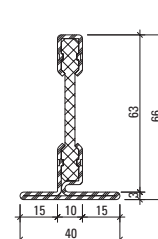

602.613 Z

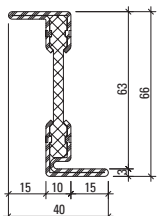

603.612 Z  
603.612.01  
603.612.09

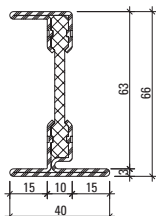

605.612 Z

**Part no.**  
with Z = hot-dip galvanised steel

with 01 = Stainless steel, bright, material 1.4401 (AISI 316)  
with 09 = Steel KB DOCOL 355W (Corten)

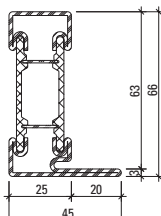

601.632 Z

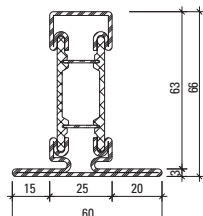

602.632 Z

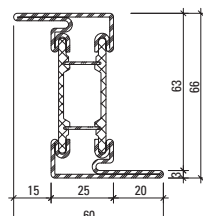

603.632 Z

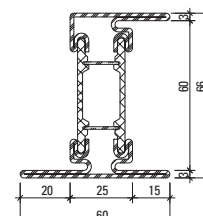

605.632 Z

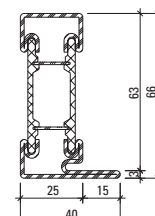

601.645 Z

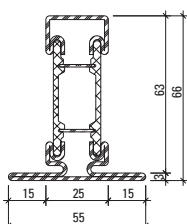

602.645 Z

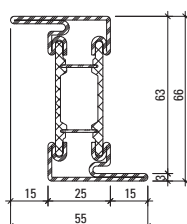

603.645 Z

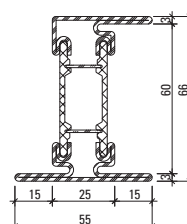

605.645 Z

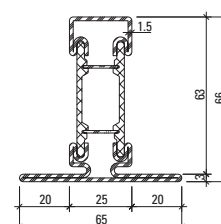

602.633 Z

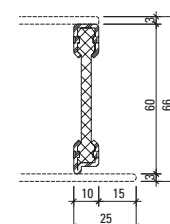

600.612 Z

Example of Janisol Arte 66

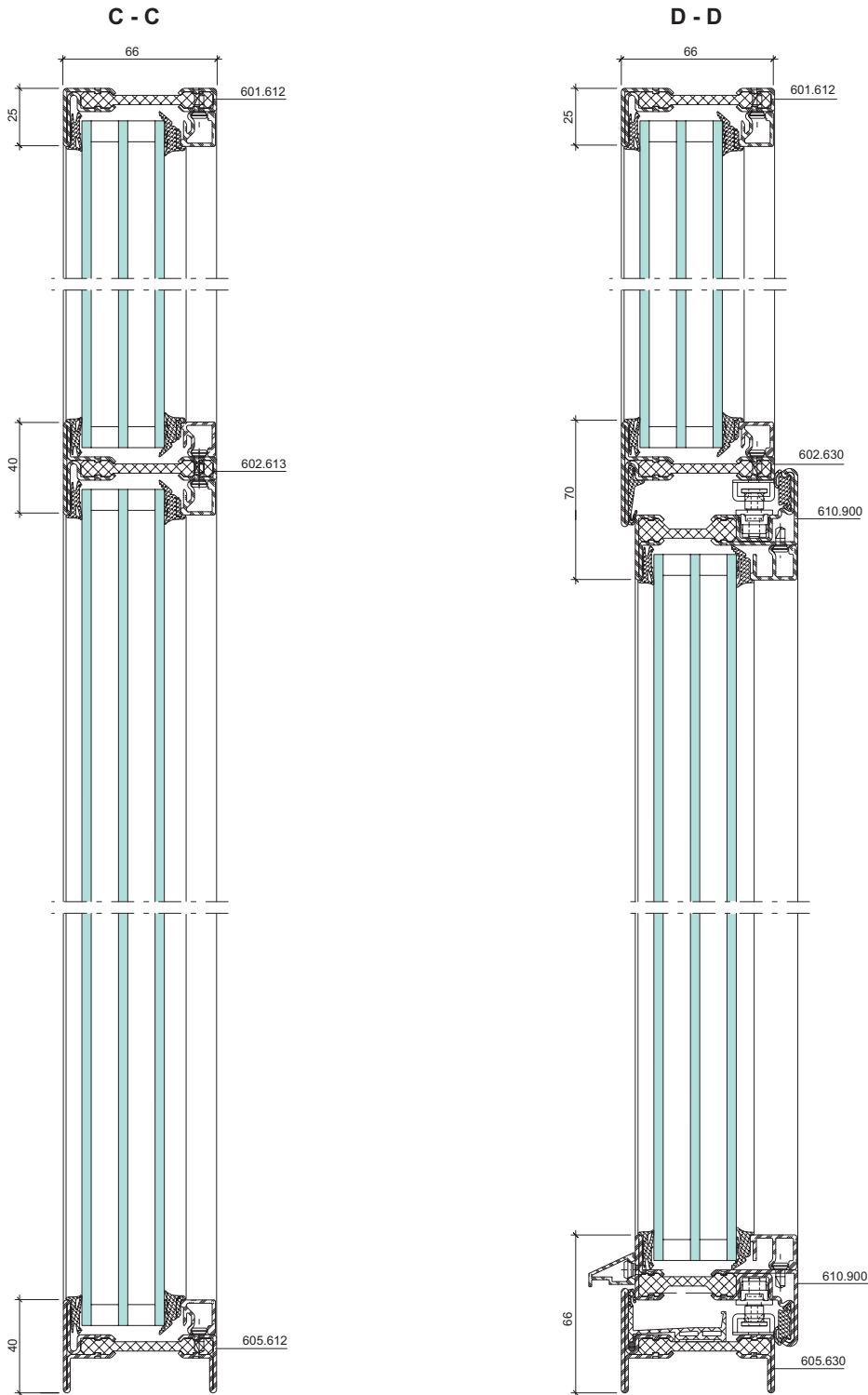



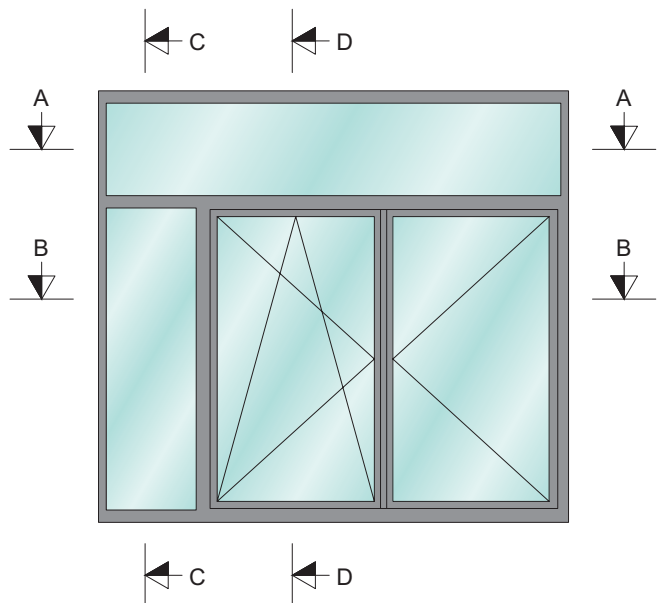
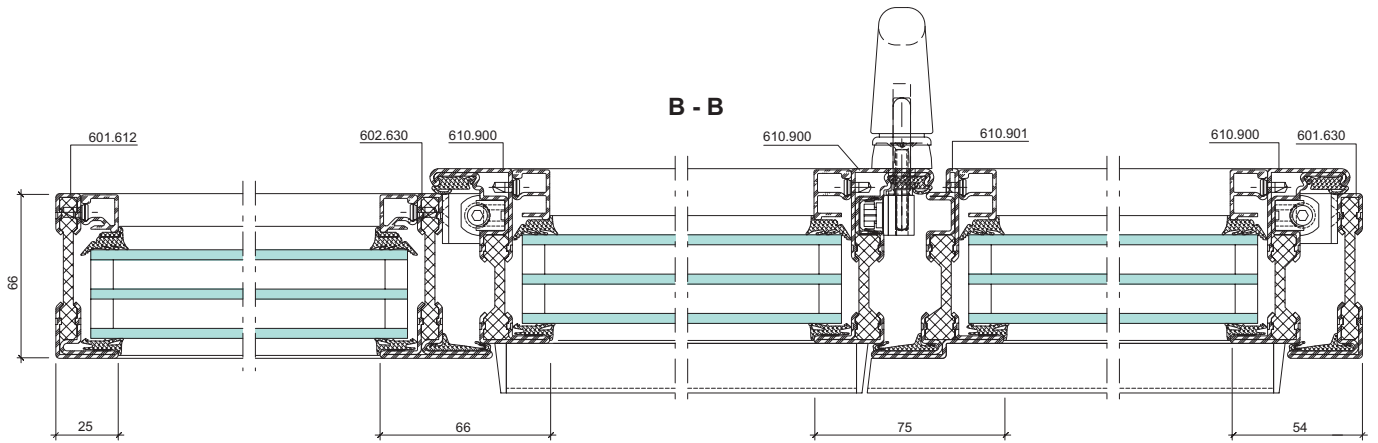
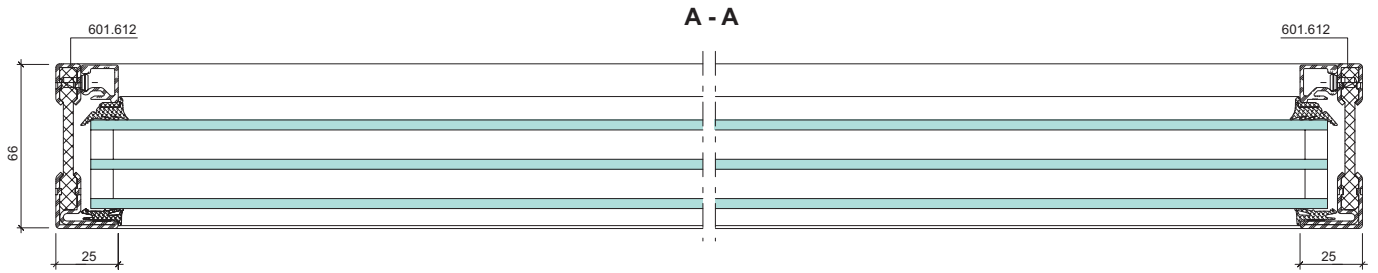

# Janisol lift-and-slide doors

## A fabulous outlook



### Redefining spaces

The Janisol lift-and-slide doors allow the inside and outside to merge, creating a bright and open environment – in luxury homes, as well as in restaurants or hotels. The robust, highly thermally insulated steel profiles enable slimline frames for large window glazing. Janisol lift-and-slide doors are also distinguished by their straightforward fabrication and installation. Despite a comparatively small basic depth of 80 mm and profile face widths of just 85 mm, leaf sizes of up to 4270 mm in width and 3210 mm in height can be constructed as lift-and-slide doors using this steel profile system. In the standard design, leaf weights of up to 400 kg are possible; as a special design, weights of up to 600 kg are possible. The chosen basic depth allows for the installation of triple insulating glass up to 57 mm in thickness. This glass can achieve  $U_w$  values to  $0.9 \text{ W/m}^2\text{K}$ . The bottom threshold profile made of glass fibre-reinforced plastic is also available for optimum thermal insulation. This means that the threshold can be designed for easy access. Designs up to RC2 are likewise possible for all opening types and motorised systems.



### Profile range

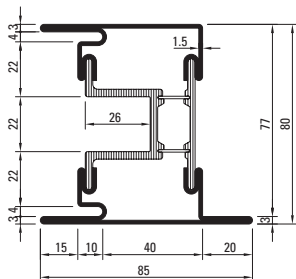

630.920  
630.920 Z

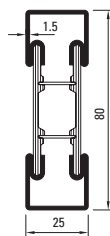

600.012  
600.012 Z

Example of Janisol lift-and-slide door

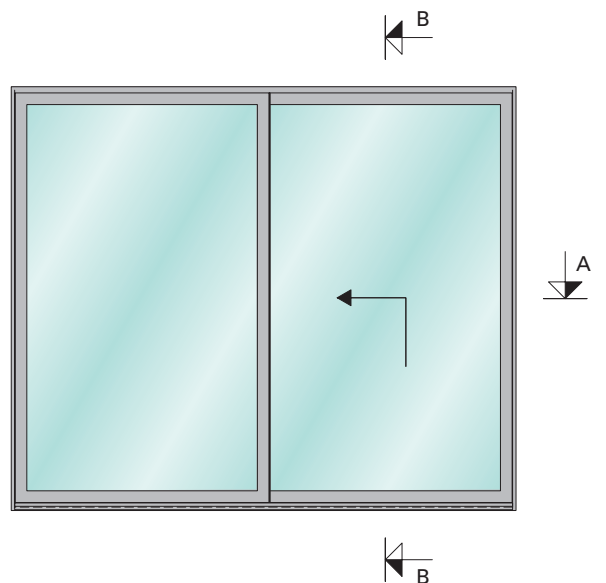
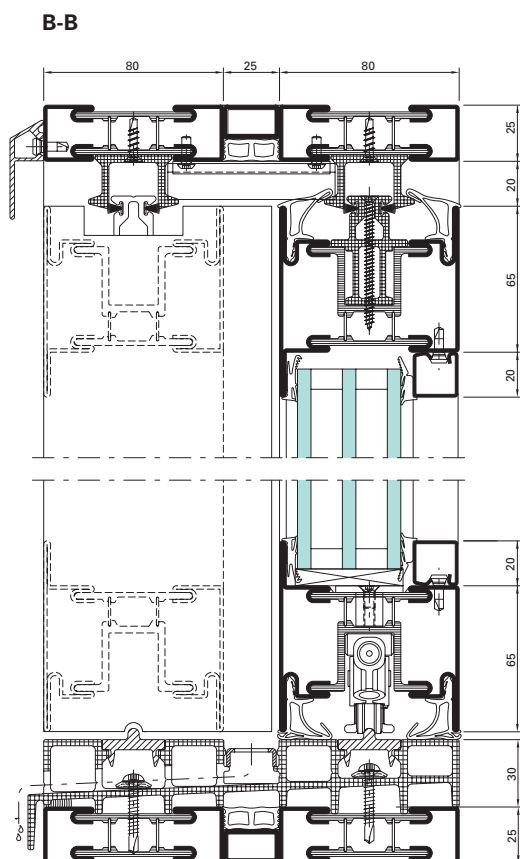
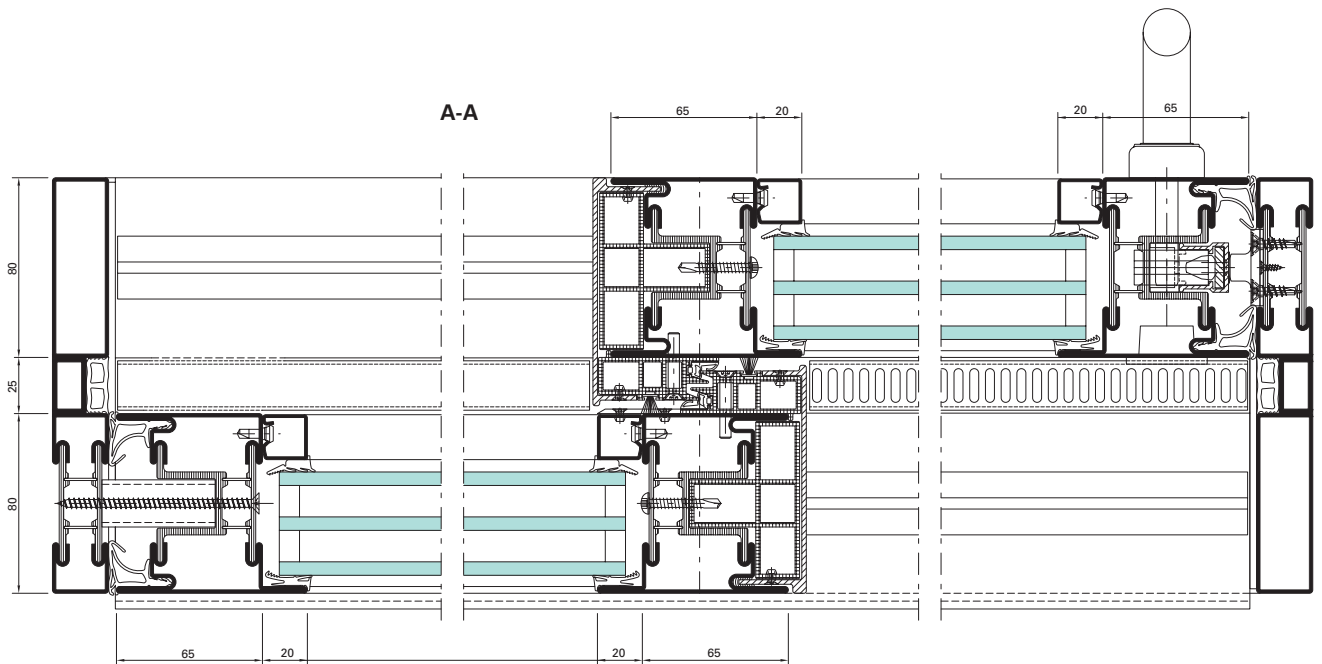



# Glazing beads

## Steel and aluminium

### Steel glazing beads made of strip galvanised steel (length 6 m)

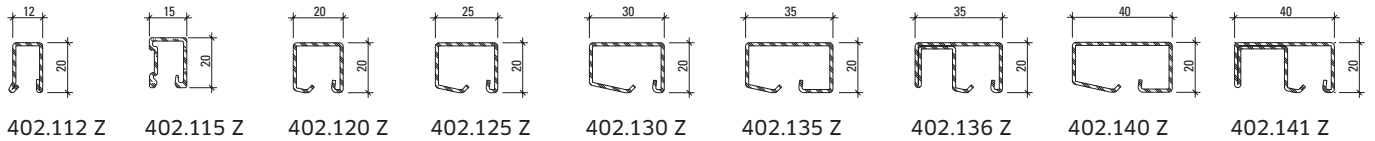

402.112 Z    402.115 Z    402.120 Z    402.125 Z    402.130 Z    402.135 Z    402.136 Z    402.140 Z    402.141 Z

### Stainless steel glazing beads (length 6 m)

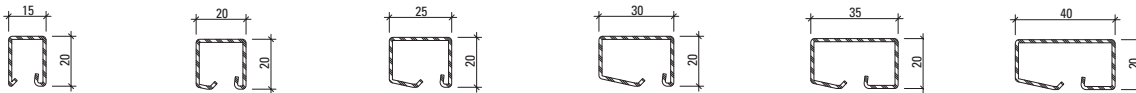

402.515    402.520    402.525    402.530    402.535    402.540  
 402.415    402.420    402.425    402.430

### Aluminium glazing beads (length 6 m)

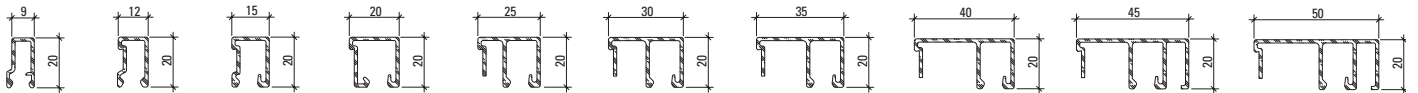

404.109    404.112    404.115    404.120    404.125    404.130    404.135    404.140    404.145    404.150

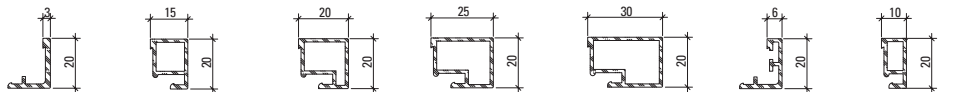

405.103    405.115    405.120    405.125    405.130    405.106    405.110

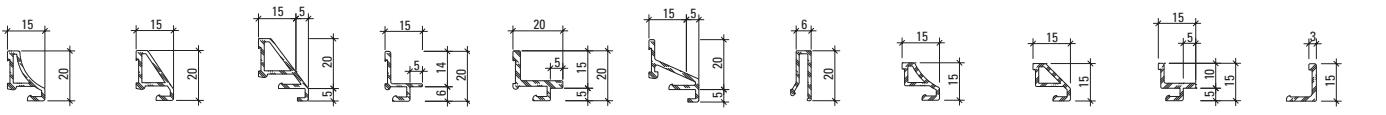

406.905    406.907    406.901    406.903    406.909    406.996    406.910    406.930    406.931    406.932    406.933

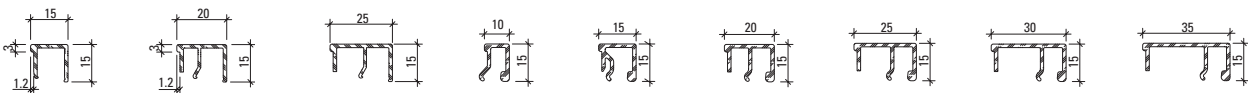

405.021    405.022    405.023    405.030    405.031    405.032    405.033    405.034    405.035

### Angle contour steel glazing beads (length approx. 6 m)

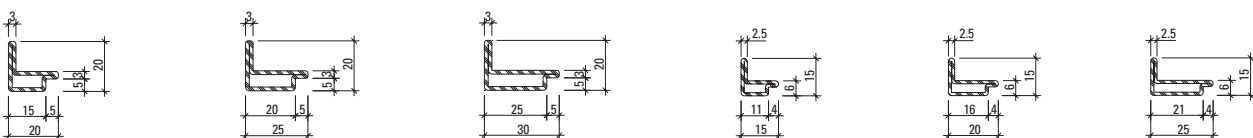

62.507 Z    62.508 Z    62.509 Z    62.510 Z    62.511 Z    62.512 Z

# System versatility: for every application



**Non-insulated profile systems  
made from steel and stainless steel**

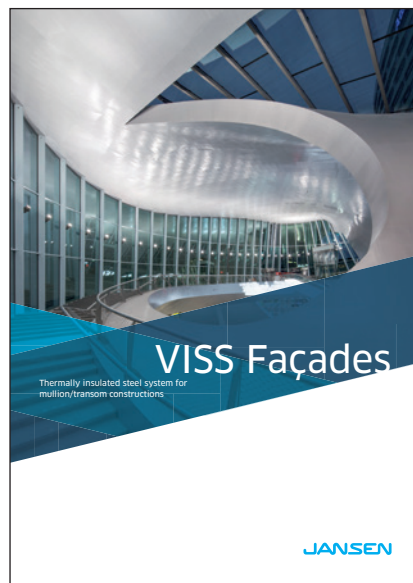

**Thermally insulated steel system for  
mullion/transom constructions**



**Smoke and fire doors and glazing**

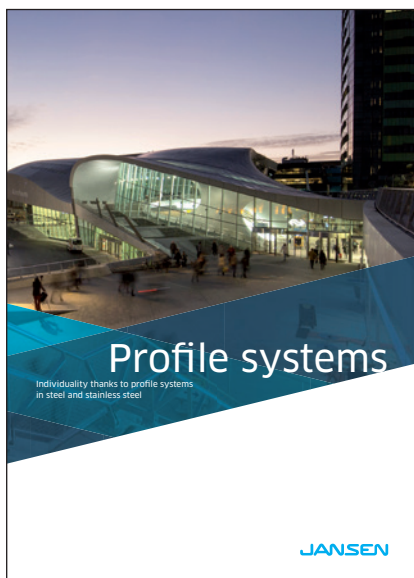

**Individuality thanks to profile systems  
in steel and stainless steel**

You can find further brochures and documentation in our download centre at [jansen.com](http://jansen.com).

If there are any differences between this document and the current German version (item number 598.809), the latest version of the original German text in the Jansen Docu Center shall prevail.

598.804 | Steel Systems | 07.2021 | Subject to change

Jansen AG

**Steel Systems**  
Industriestrasse 34  
9463 Oberriet  
Schweiz  
[jansen.com](http://jansen.com)

**JANSEN**